

Darstellung mit geöffnetem Deckel /
view with open cover

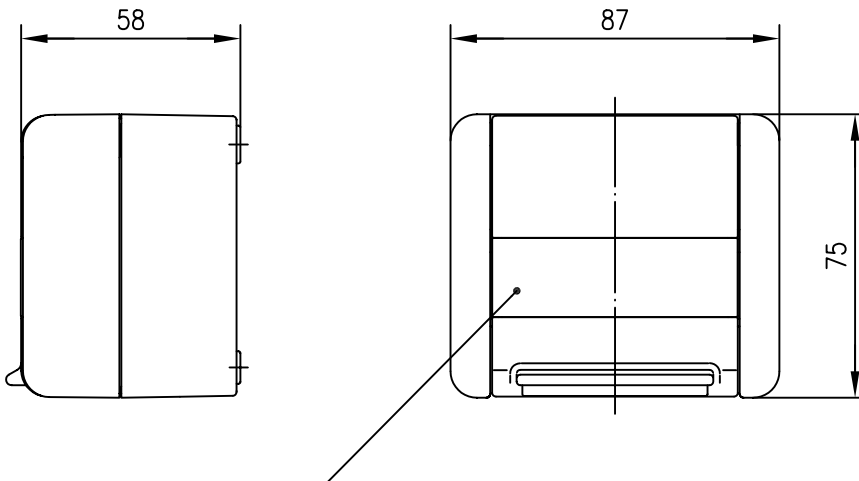

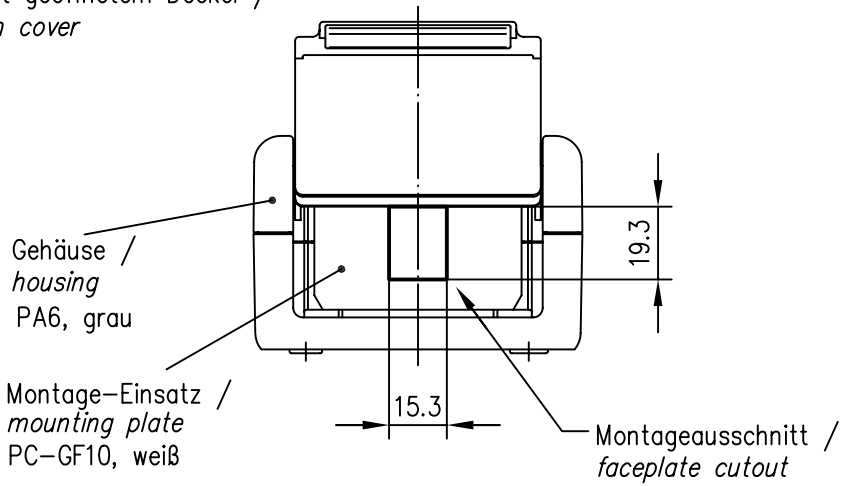
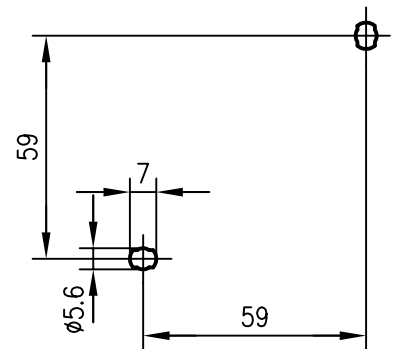

Beschriftungsschild mit Klarsichtabdeckung
marking label with transparent cover

Befestigungsmaße /
dimensions for fixing



Verpackung / Packing:

Einzelverpackung in Karton (110x90x90) /
single packed in carton

				2006	Datum/date	Name/name	Werkstoff/ material	
				gez./drawn	01. 02.	SK		
				gepr./appr.	06.02.06	KA	Oberfläche/ finish	
				Norm/stand.				
				Maßstab/scale	Benennung/title			
				1: 2	Gehäuse AP IP44 für 1xAMJ-Modul Housing AP IP44 for 1xAMJ-module			
				untol. Maße/ dim. without tolerances according to	Unteri./doc.type	Zeichnungsnr./drawing no.		
				K	H02000A0069			
				Ersatz für/ replaces				
							 Telegärtner  Maße/dimensions: mm Original: DIN A4	
Änd./rev. Index	Änderungsmittlung/ revision code	Datum/ date	Name/ name					